

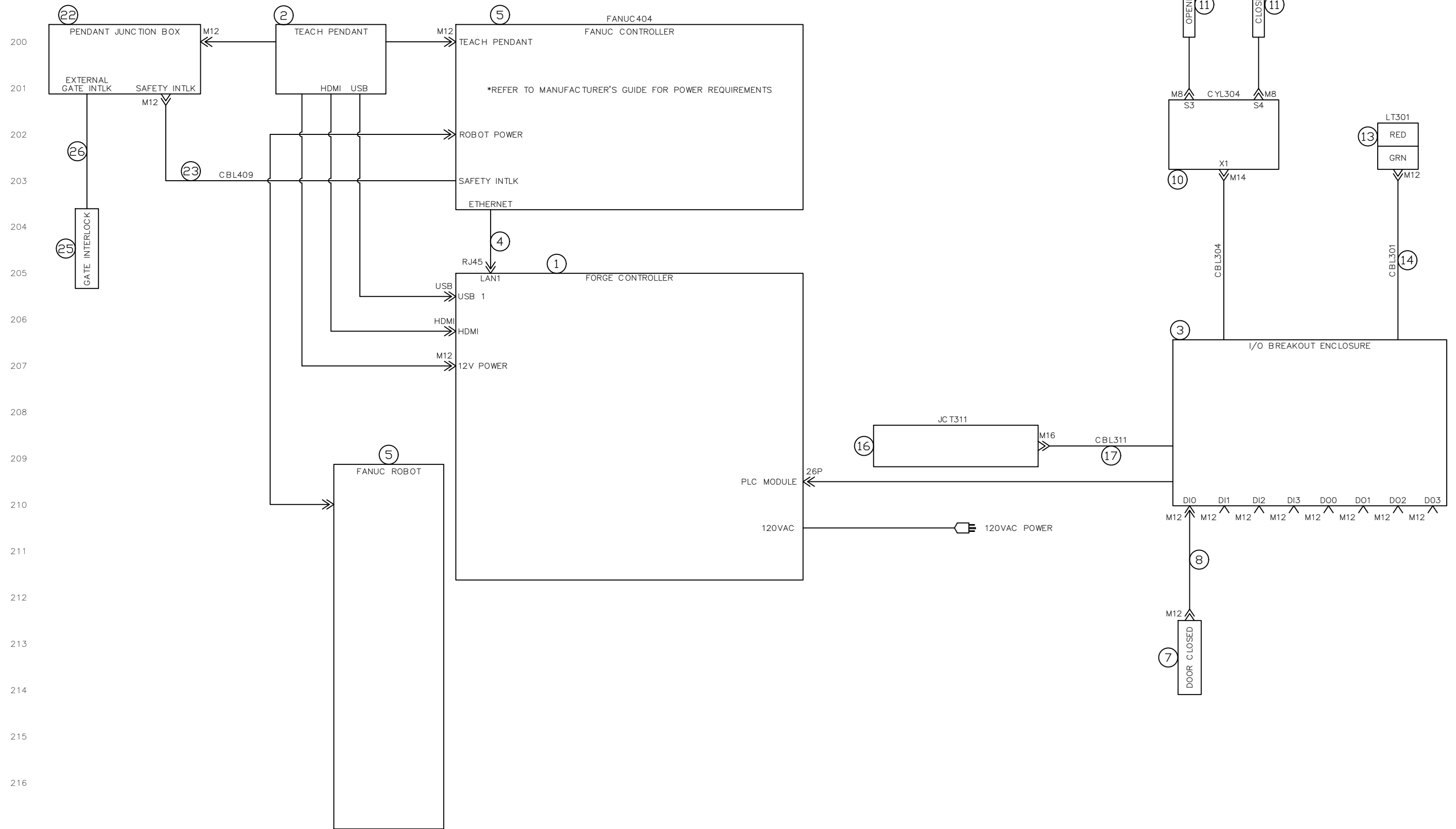

ELECTRICAL DRAWING LIST	
SHEET	DESCRIPTION
R-101224-E01-01	TITLE SHEET
R-101224-E01-02	SYSTEM LAYOUT
R-101224-E01-03	I/O BREAKOUT ENCLOSURE
R-101224-E01-04	R-30iB MATE PLUS ROBOT SAFETY CONNECTIONS
R-101224-E01-05	BILL OF MATERIALS

					JOB NUMBER: R-101224		TITLE: TITLE SHEET TURN-KEY LATHE TENDING M-20iA & ACE					
					APPROVALS	DATE	CUSTOMER:					
					DRAWN T. HAYDEN	14-JUL-2020	SIZE B			DO NOT SCALE DRAWING	DWG. NO. R-101224-E01	REV. -
					CHECKED		SCALE N/A			REF	SHEET 01 OF 05	
					APPROVED							
					ISSUED							
REV. LTR.	REVISION DESCRIPTION	DRAWN BY	DATE	APPROVED BY	TOLERANCES UNLESS OTHERWISE SPECIFIED INCHES: .X DIM'S ±.02, .XX DIM'S ±.01, .XXX DIM'S ±.005 MILLIMETERS: X DIM'S ±0.5, XX DIM'S ±0.3, XXX DIM'S ±0.13 FRACTIONS ±1/64", ANGULAR DIM'S ±1° FLATNESS & PERPENDICULARITY .001" OVER 6", .002" OVER 12", .005" 12" AND OVER		PARTS MUST BE: RoHS COMPLIANT AND LEAD FREE NO ROLL FORM THREADS. SURFACE FINISH: 63 BREAK ALL SHARP EDGES .015 MAX. DIMENSIONS APPLY AFTER PLATING UNLESS OTHERWISE NOTED.	PROPRIETARY AND CONFIDENTIAL: THE INFORMATION CONTAINED IN THIS DRAWING IS THE SOLE PROPERTY OF READY ROBOTICS. ANY REPRODUCTION IN PART OR AS A WHOLE WITHOUT THE WRITTEN PERMISSION OF READY ROBOTICS IS PROHIBITED.	MATERIAL	FINISH		
					NOTE: UNTOLERANCED DIMENSIONS REFERENCING TRUE POSITIONS ARE BASIC		PARTS MUST BE FREE OF IRREGULARITIES PRIOR TO ANY SURFACE FINISH					



NOTE: SEE SHEET 03 FOR DETAILED I/O BREAKOUT ENCLOSURE WIRE CONNECTIONS

SYSTEM LAYOUT

 READY Robotics 1080 Steelwood Rd. Columbus, OH 43212	SIZE	DWG. NO.	REV
	B	R-101224-E01	-
DRAWN T. HAYDEN	SCALE N/A	SHEET 02 OF 05	

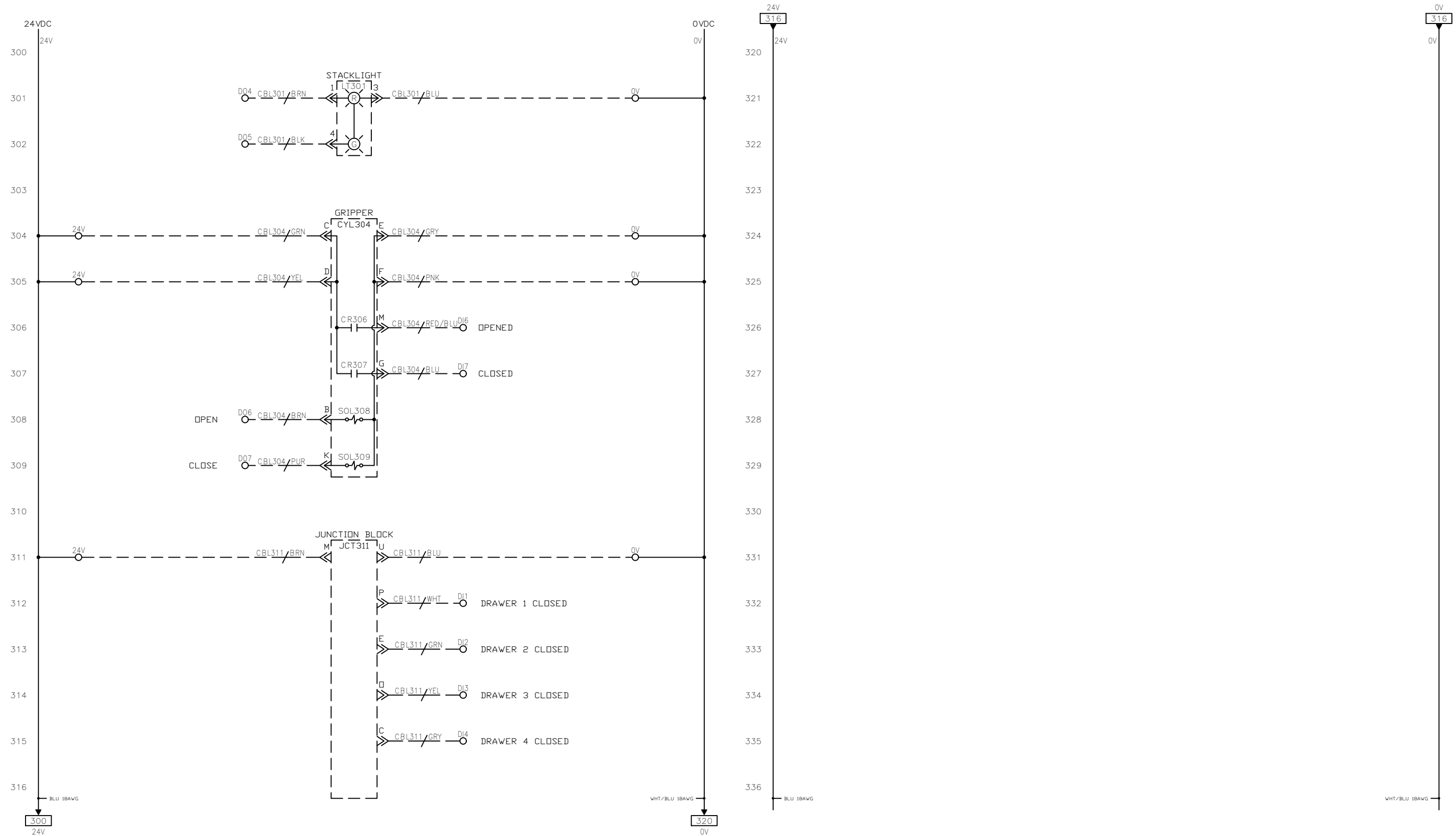

NOTE: ALL 24VDC WIRES ARE BLU 18AWG AND ALL 0VDC WIRES ARE WHT/BLU 18AWG UNLESS OTHERWISE STATED

I/O BREAKOUT ENCLOSURE

 READY Robotics 1080 Steelwood Rd. Columbus, OH 43212	SIZE	DO NOT SCALE DRAWING	DWG. NO.	REV
	B		R-101224-E01	-
DRAWN T. HAYDEN		SCALE N/A	SHEET 03 OF 05	

400
401
402
403
404
405
406
407
408
409
410
411
412
413
414
415
416
417
418
419
420
421
422
423
424
425
426
427

FANUC 404

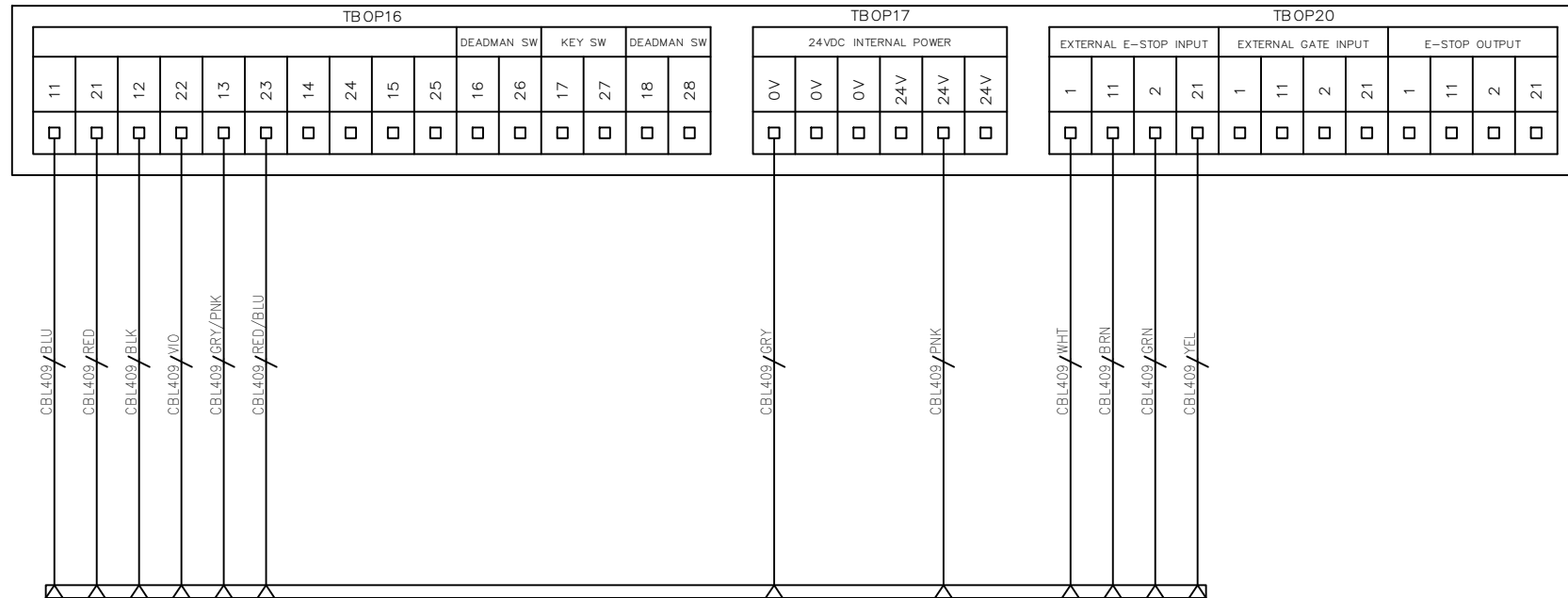

R-30iB MATE PLUS ROBOT SAFETY CONNECTIONS

 READY Robotics 1080 Steelwood Rd. Columbus, OH 43212	SIZE	DO NOT SCALE DRAWING	DWG. NO.	REV
	B		R-101224-E01	-
DRAWN T. HAYDEN		SCALE N/A	SHEET 04 OF 05	
ISSUED				

BILL OF MATERIALS			
ITEM	QTY	DESCRIPTION	PART NUMBER
1	1	CONTROLLER, FORGE, 120VAC, 16DIO	READY ROBOTICS R-100144
2	1	PENDANT, FORGE	READY ROBOTICS R-101078
3	1	EXPANSION, BREAKOUT, BOARD, I/O, 24VDC	READY ROBOTICS R-101080
4	1	CABLE, CORDSET, RJ45, 5M	TURCK RJ45S-RJ45S 441-5M
5	1	ROBOT, KIT, CONTROLLER, 1811MM, 20KG	FANUC M20iA
6			
7	1	SENSOR, DIFFUSED, 12MM, 24VDC, PNP	BALLUFF BOS01WP
8	1	CABLE, CORDSET, M12, 5 PIN, 5M	BALLUFF BCC09H3
9			
10	1	PNEUMATIC, VALVE BLOCK, 4 PORT	SCHUNK 0310072
11	2	SWITCH, REED, M8, 24VDC, PNP	SCHUNK MMS 22-S-M8-PNP
12			
13	1	LIGHT, STACK, M12, 24VDC, GRN - RED	BANNER TL50GRQ
14	1	CABLE, PATCHCORD, M12, 4 PIN, FEMALE, 9M	BANNER MQDC-430
15			
16	1	JUNCTION BOX, PICOFAST, M8, 3 PIN, 8 PORT, PNP	TURCK VB 803M-PX9-BS14
17	1	CABLE, PATCHCORD, VERSAFEST, M16, 14PIN, FEMALE, 10M	TURCK BKM 14-836-10
18			
19			
20			
21			
22	1	PENDANT JUNCTION BOX	READY ROBOTICS R-101084
23	1	CABLE, PATCHCORD, M12, 12 PIN, FEMALE, 5M	PHOENIX CONTACT 1554872
24			
25	0	SWITCH, SAFETY, GATE INTERLOCK	SIEMENS 3SE5 312 1SG11
26	33'	CABLE, PATCHCORD, 18C, 24AWG, O.D. 10.41MM	IGUS CF130-02-018-UL

G:\Shared drives\Team - Integrations\11 - Internal Projects\R-101224_Turn-key_M20iA ACE Lathe\R-101224-E01R-101224-E01-05.dwg, Model, 7/14/2020 11:49:37 AM, travis.hayden

BILL OF MATERIALS

	READY Robotics 1080 Steelwood Rd. Columbus, OH 43212	SIZE	DO NOT SCALE DRAWING	DWG. NO.	REV
	DRAWN T. HAYDEN	B		R-101224-E01	-
ISSUED	SCALE N/A	SHEET 05 OF 05			