









2 Finger Parallel SoftGripper

Cone Angle 60°, 75° & 90°



Connector	60° Cone Angle	75° Cone Angle	90° Cone Angle
ISO 9404-1-31.5-2-M5	 SG.2P.60D.31	 SG.2P.75D.31	 SG.2P.90D.31
ISO 9409-1-40-4-M6	 SG.2P.60D.40	 SG.2P.75D.40	 SG.2P.90D.40
ISO 9409-1-50-4-M6	 SG.2P.60D.50	 SG.2P.75D.50	 SG.2P.90D.50
Typical Gripping Objects	<ul style="list-style-type: none"> • Rectangular or Cubic • Feed size 15 mm – 115 mm • Weight < 200 g 	<ul style="list-style-type: none"> • Rectangular or Cubic • Feed size 10 mm – 90 mm • Weight < 200 g 	<ul style="list-style-type: none"> • Rectangular or Cubic • Feed size 5 mm – 40 mm • Weight < 200 g



2 x Finger Shore A60
side60S



1 x Vacuum Suction Cup
(optional accessory)

2 Finger Parallel SoftGripper

Cone Angle 60°, 75° & 90°

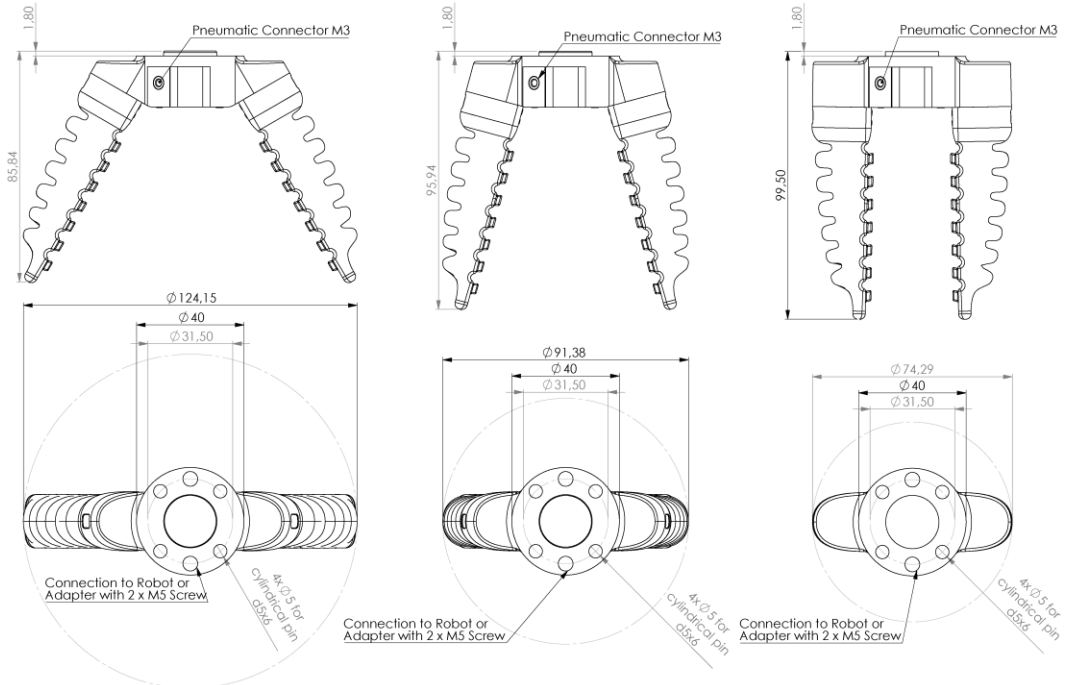

Finger Material	Silicone
Operating Pressure	- 0.5 to 1.0 bar
Grip Force per Finger	5 N
Durability	> 10 Mio. Cycles @1.0 bar, 0.5 Hz
Connector ¹	ISO 9404-1-31.5-2-M5
Air Pressure Connection	2 x M3
Total Height 60° 75° 90°	85,84 95,94 99,50 mm
Total Diameter 60° 75° 90°	124,15 91,38 74,29 mm
Mass	143 g

¹ Other connectors available, e.g. ISO 9409-1-50-4-M6 for Universal Robots.

Available SoftGripper Adapters

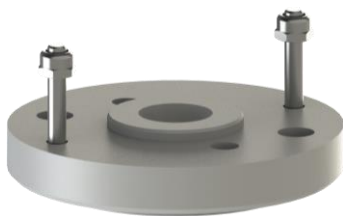

RBTX Delta Robot Connector
SG.C.31.NE.17

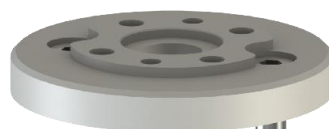

ISO 9409-1-40-4-M6 Connector
SG.C.31.40



ISO 9409-1-50-4-M6 Connector
SG.C.31.50